

注：接入交换机数量详办公网综合布线系统图

办公网信息网络拓扑图

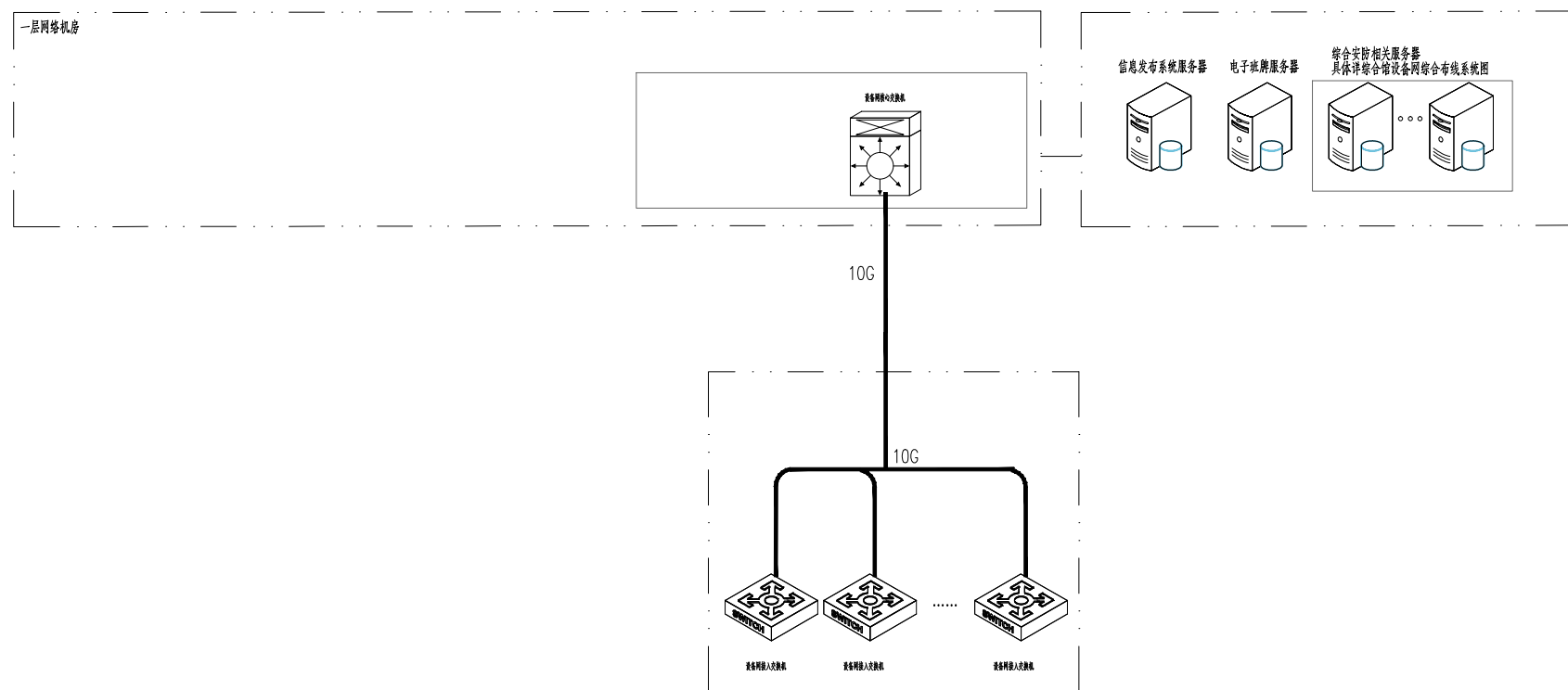

注：接入交换机数量详设备网综合布线系统图

设备网信息网络拓扑图

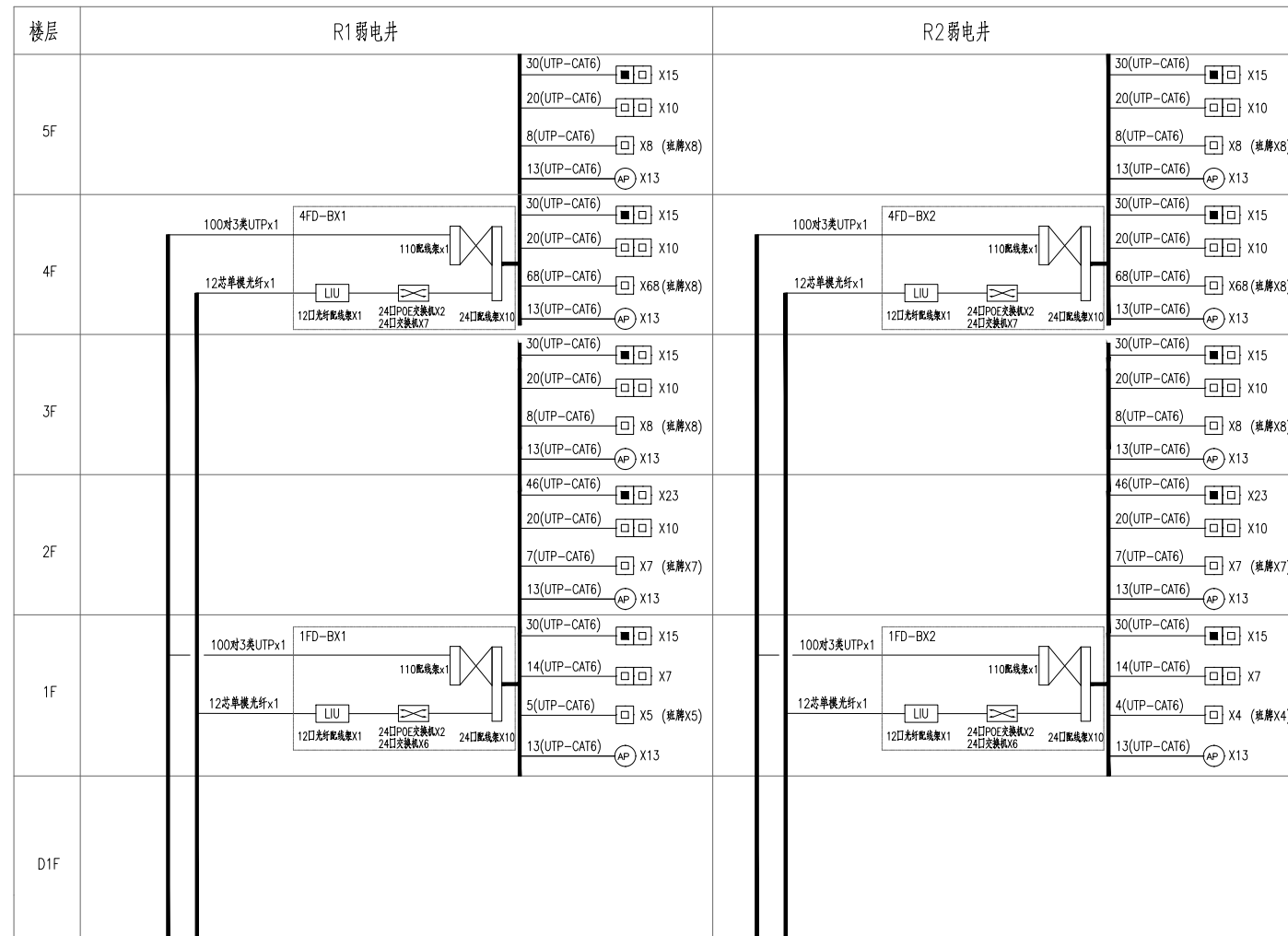

SR 300x150 综合布线系统干线线槽

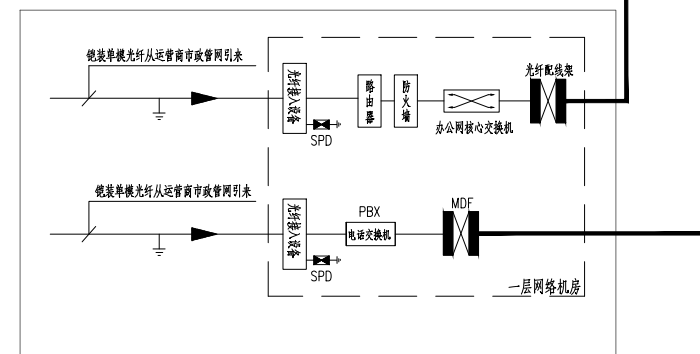

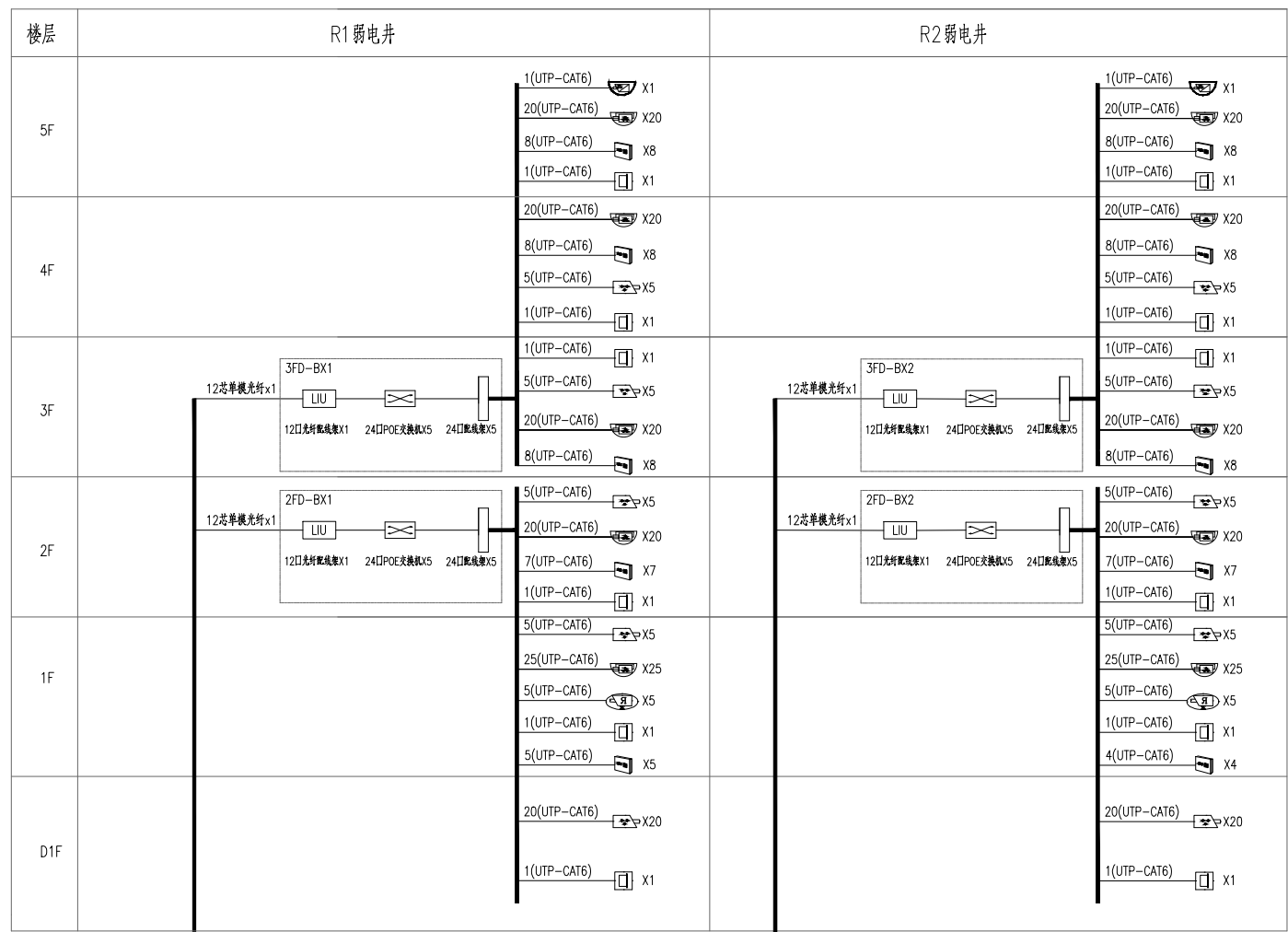

SR 300x100
综合布线系统干线线缆槽

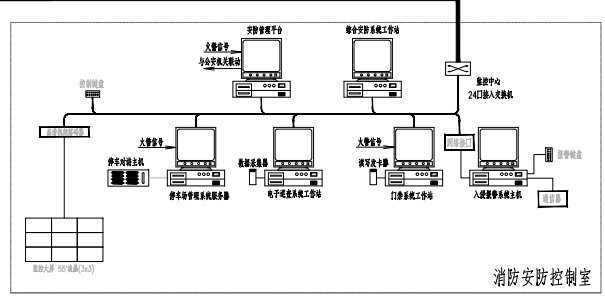
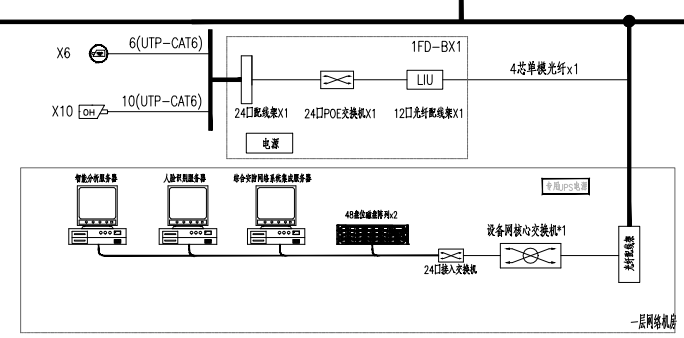

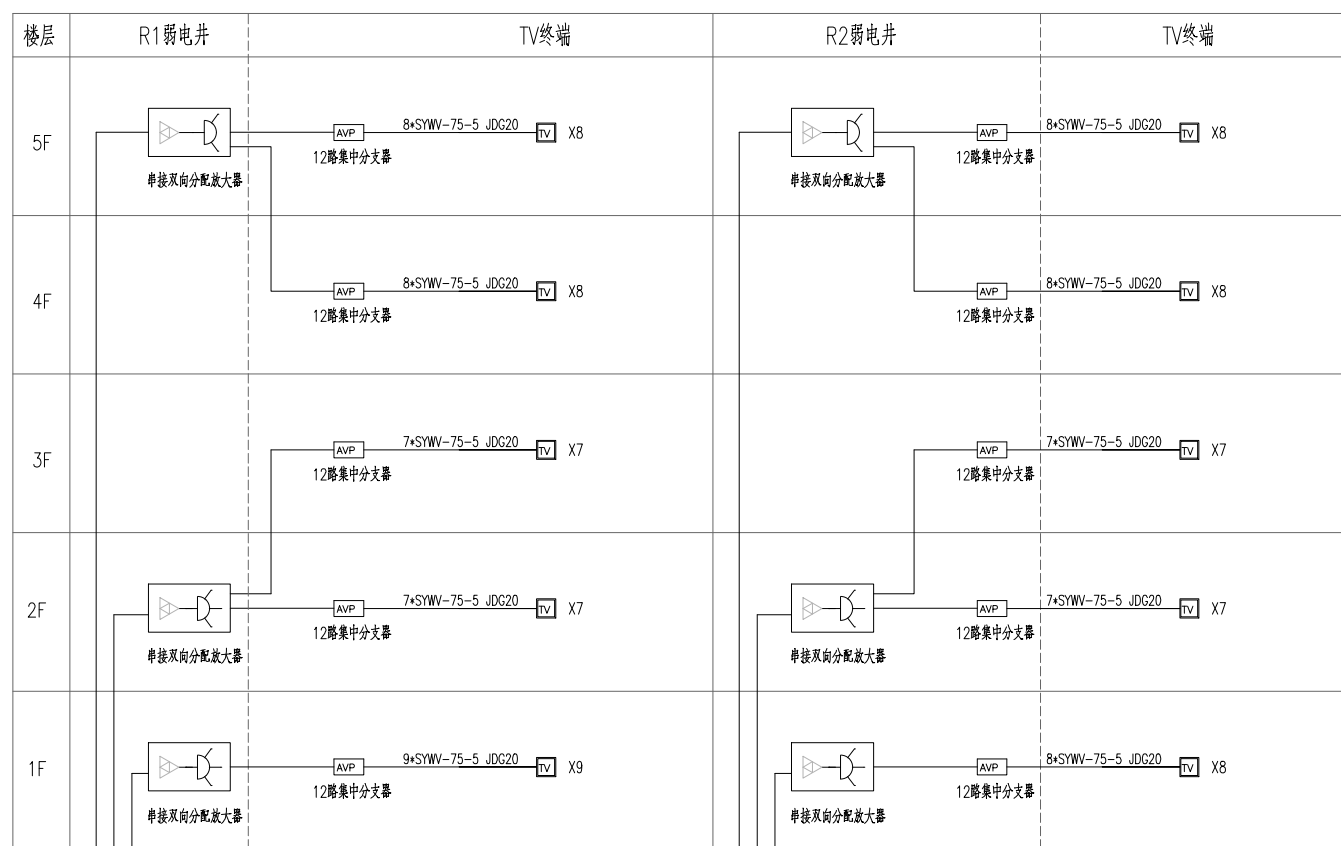

SYWV-75-12同轴电缆(余同)





SYWV-75-12同轴电缆(余同)

6xSYWV-75-12由网络机房引来

有线电视系统图

注：1.集中分支器内设终端匹配电阻。
2.图中SPD由普通避雷器配套带来

图例

-  双向传输二分配器
-  双向传输三分配器
-  双向传输四分配器
-  双向传输四分支器
-  集中分支器

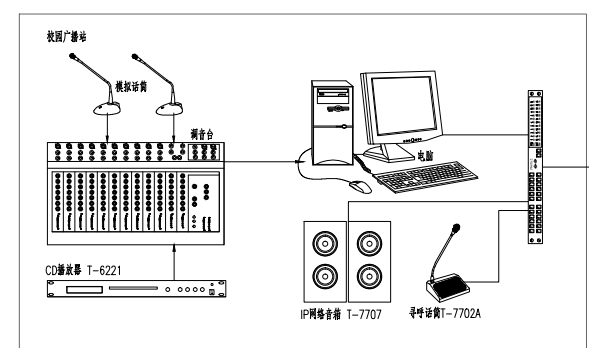
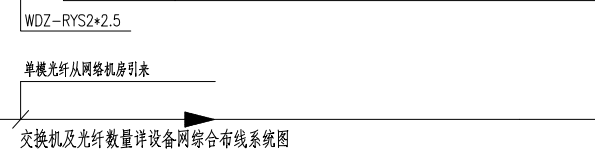
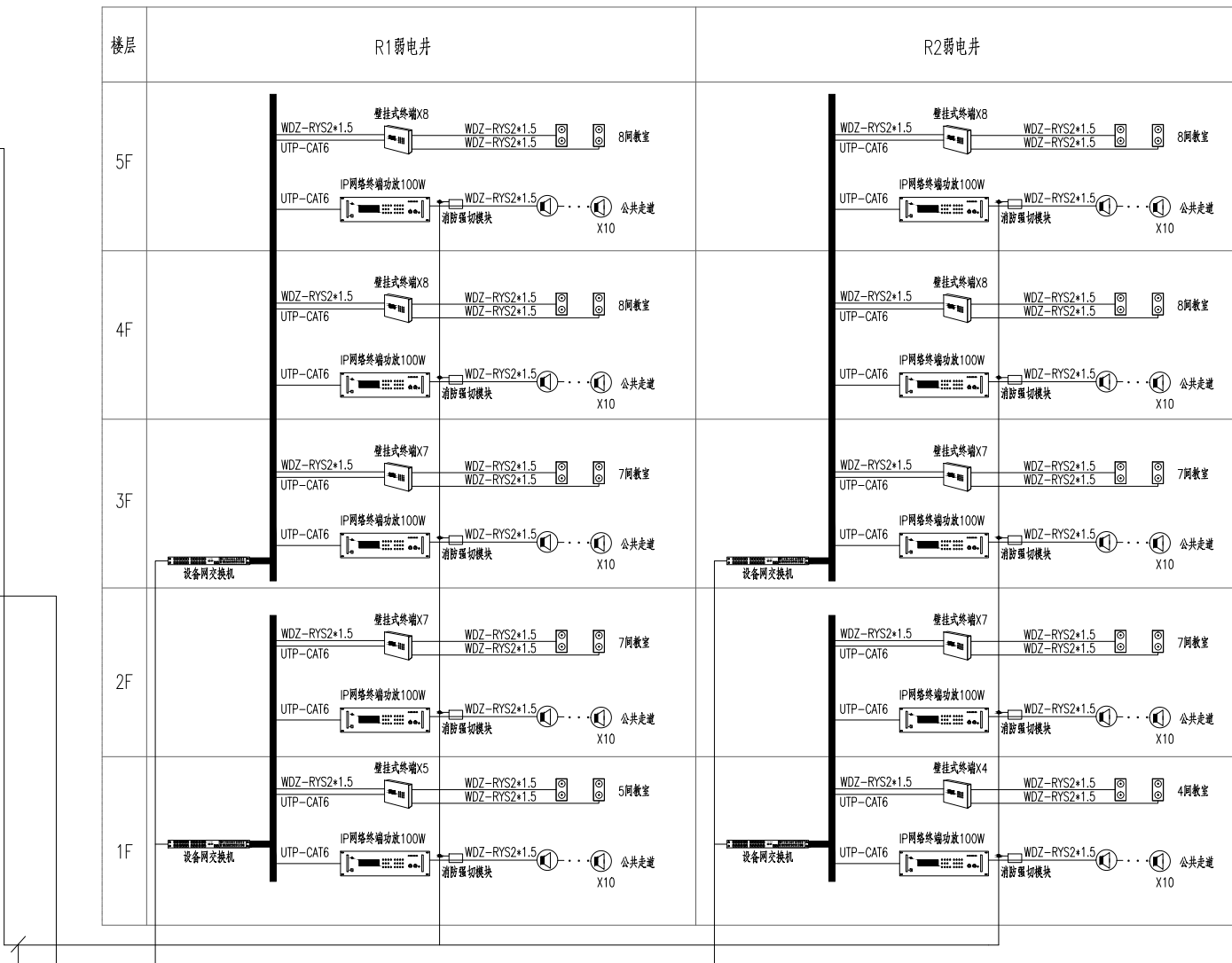
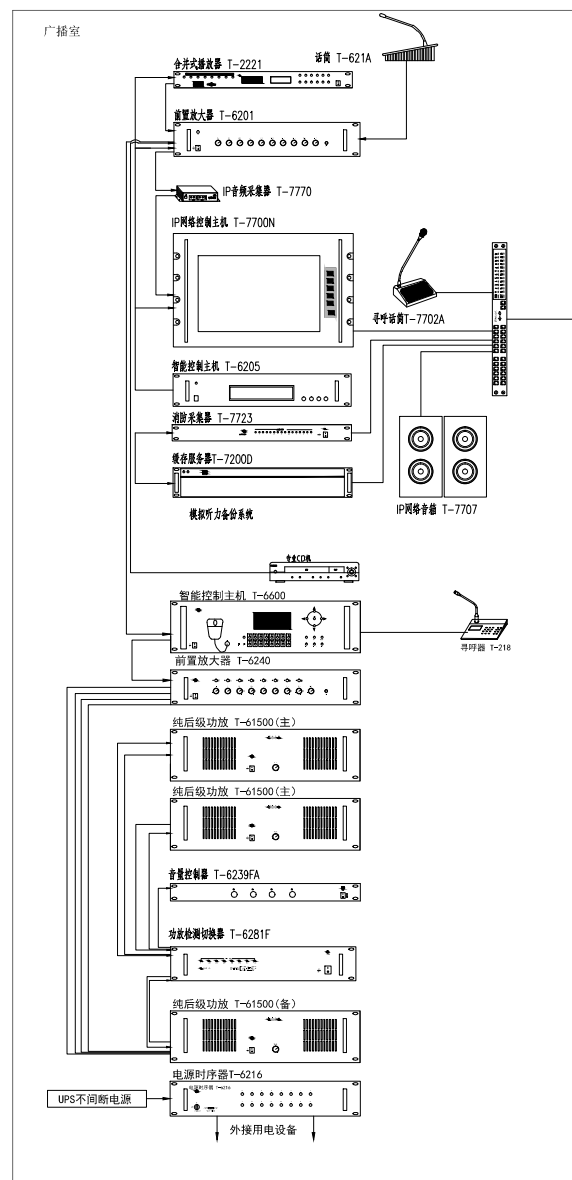
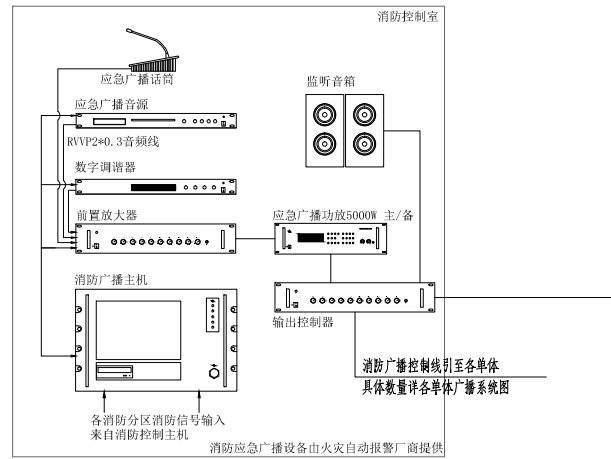

公共广播兼消防广播系统图

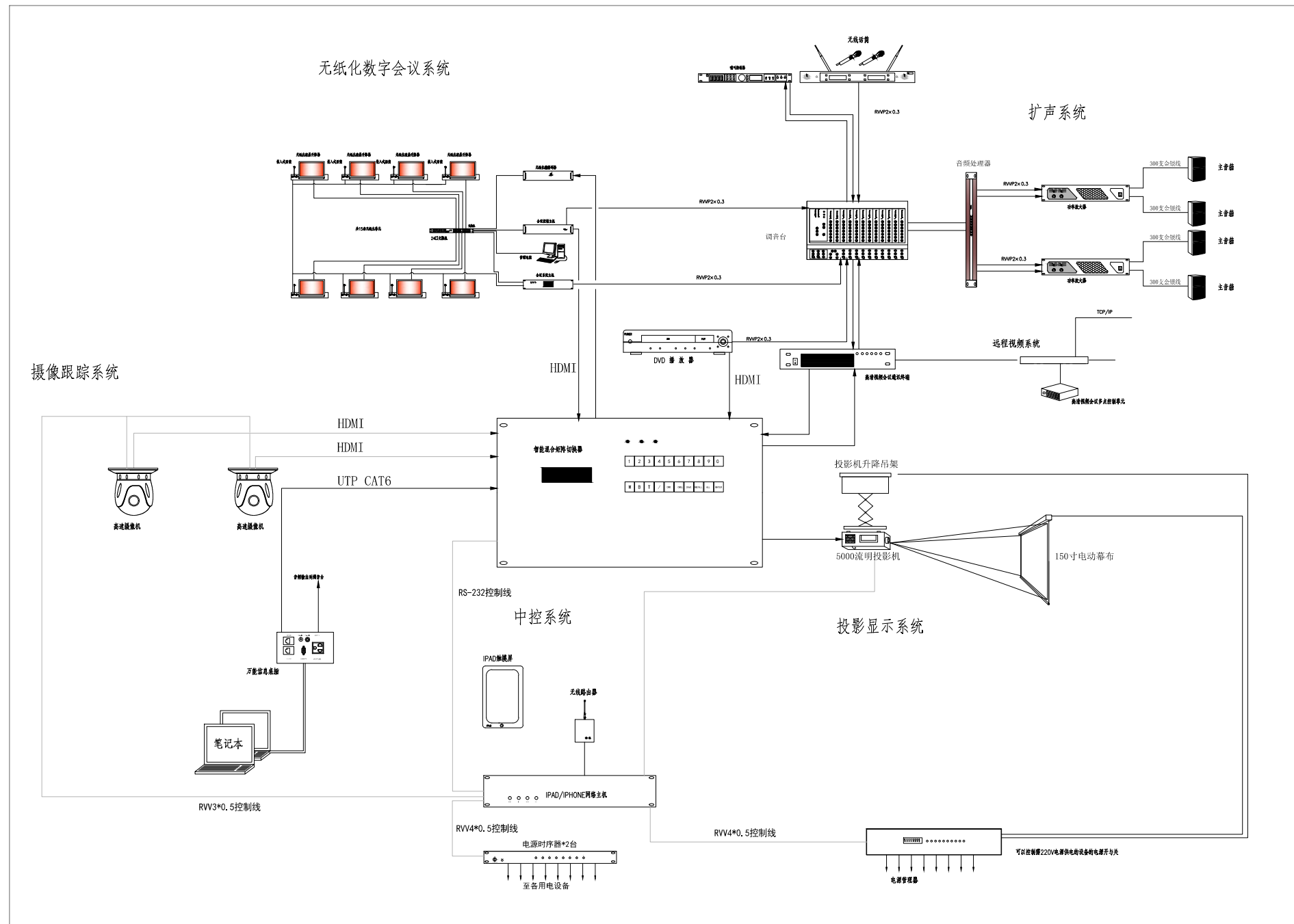

数字会议系统图

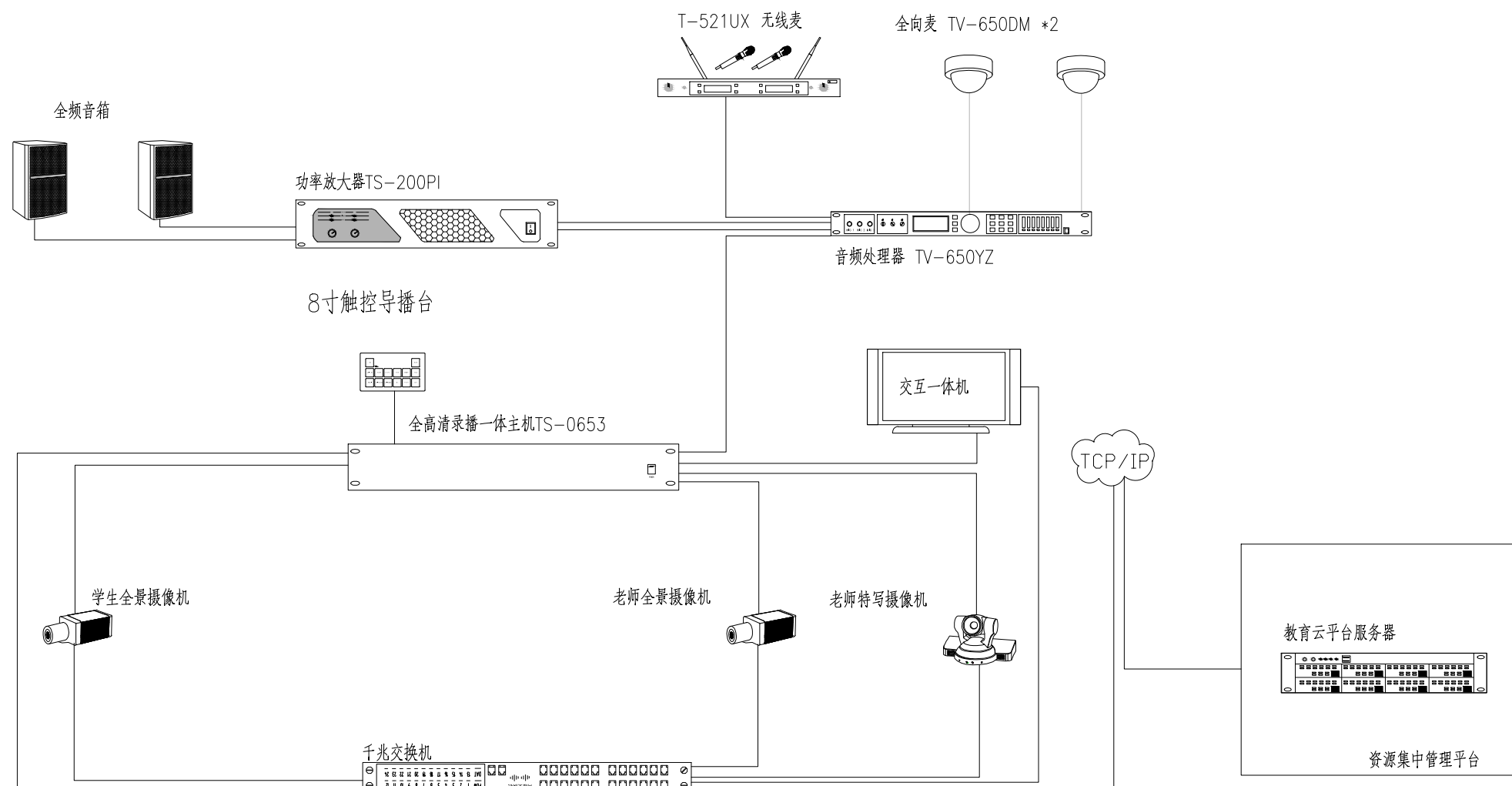

常态化教学录播系统图

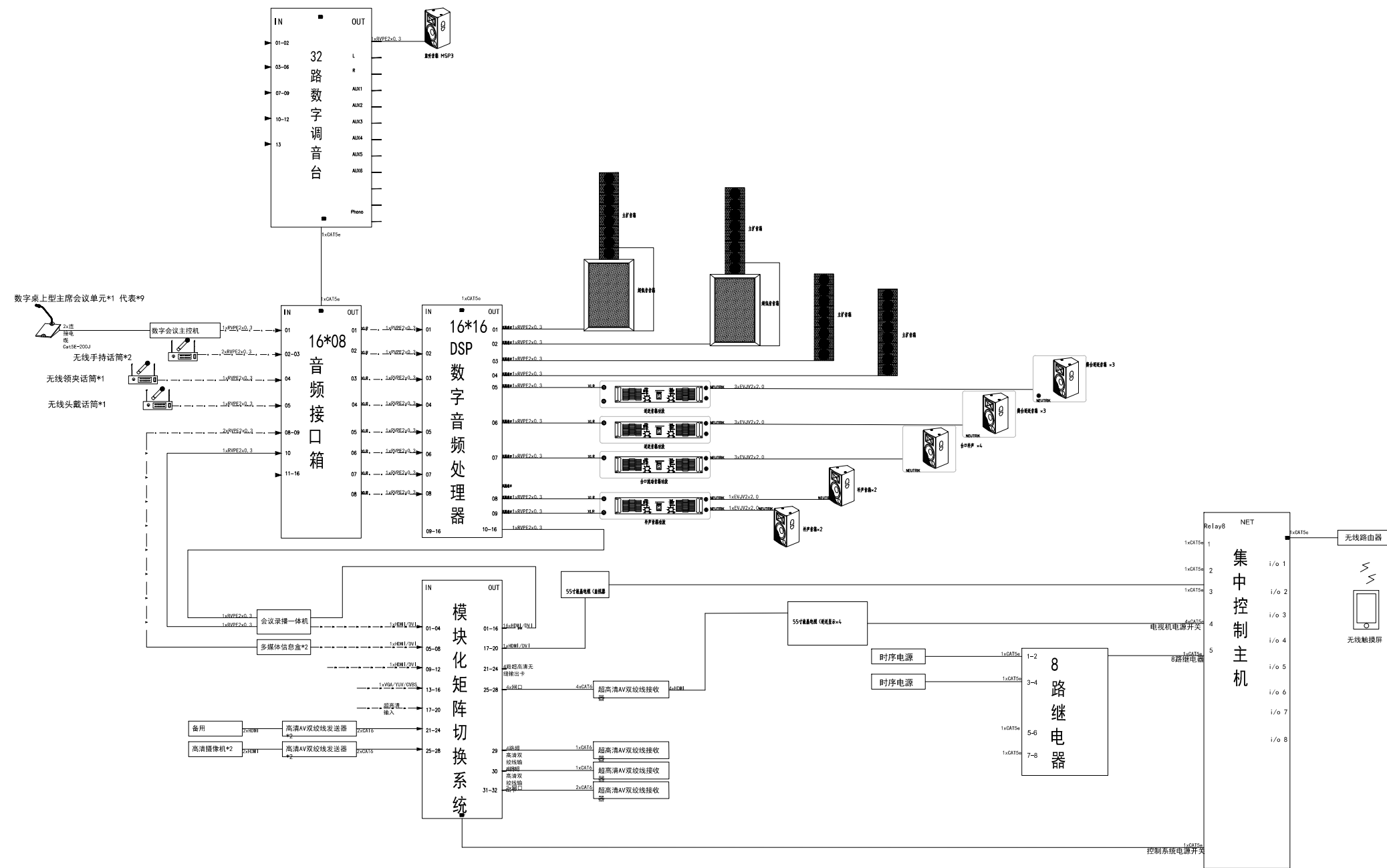

大报告厅会议系统图

